

Hydrozone™

For models released from November, 2023

Technical Information Pack



Vortex™
Spas

Interactive tech sheet

This interactive tech sheet contains clickable links and QR codes that provide instant access to specific information related to Vortex™ Spas or Swim Spas.

Simply click or scan these QR codes to dive deeper into the features, maintenance tips, and expert advice tailored just for you.

When you see these icons, you can click or scan:

Click on QR code



Scan QR code



We hope you find the information helpful. Please get in touch if you have any questions about any Vortex™ Spas product. We are here to help!

From the Vortex™ Spas Team.

Hydrozone™

 **JETS** Up to 64

 **WATER CAPACITY** 7,045 litres

 **SEATING** Up to 7 seats

 **DIMENSIONS** 5.89 x 2.30 x 1.28/1.49m



FEATURES

Build

- Heavy-duty heat-dipped galvanised, timber-free frame with a Lifetime Warranty
- Superior USA-made Aristech™ acrylic for added peace of mind
- Thermobond™ 4-Layer shell construction for superior durability
- Nine colours combinations to suit your preferences
- Duraflex™ 'No kink' PVC plumbing ensures no plumbing worries
- Thermoclad™ Maintenance-free cabinet
- ThermoLock™ Dual layer insulation to reduce energy consumption
- ThermoLock™ High Impact FRP base
- Hydroflow™ Stainless steel bearing-less jets for long life
- Dual Filter Banks for balanced swim conditions

Control

- SpaNet™ Premium control systems with dynamic thermal tuning for energy savings
- Premium SpaNet™ Touchpad for ease of use

Lighting

- Hydroglow™ Underwater LED floodlight
- Hydroglow™ LED backlit water cascade to set the scene
- Hydroglow™ Programmable lighting for full control
- Hydroglow™ Jet & topside control lighting
- Hydroglow™ Perimeter & cabinet lighting
- Hydroglow™ Backlit drink holders
- Hydroglow™ Backlit laminar jets

Water Care

- Twin Purezone™ Filter banks for maximum filtration
- Purezone™ AOS System with UV and ozone automatic water care

Hydrotherapy

- Neck Therapy Collar™ to melt away back and shoulder tension
- Hydrotherapy lounge for superior post-training relaxation
- Individual seat pressure controls for a tailored hydrotherapy experience
- Adjustable spa jets for customised massages

Optional Extras

- Vortex™ Audio WiFi Kit—Control your spa and enjoy your favourite music or podcasts
- SmartLINK™ WiFi Module—Remotely monitor and control your spa
- EcoCube™ Hybrid heat pump—Save up to 75% on spa heating costs in winter and cool your spa in summer (Spa End)
- SpaNet™ SV heat pump (Swim Spa End)
- ClearLift™ Automatic cover
- Swimming Pole

WARRANTIES

| | |
|-------------------------------|----------|
| Frame..... | Lifetime |
| Shell structure..... | 10 yrs |
| Acrylic surface..... | 5 yrs |
| Jets, plumbing & heater | 5 yrs |
| Pumps & equipment..... | 5 yrs |

* Conditions apply. Specifications may change without notice. Pictures may show options not available on all models.

** These warranties are valid for all products delivered after December 31st, 2023. Products delivered before that date are covered under the previous warranties. Please refer to the Vortex Spas warranty card attached to this tech pack to find more information.

Hydrozone™

Height Comparison

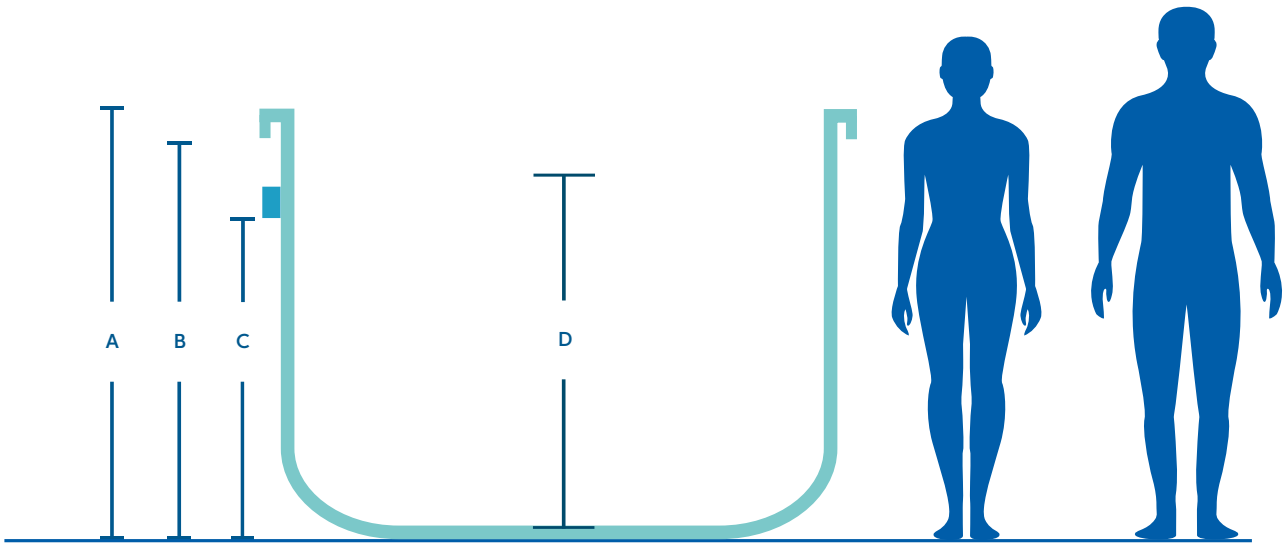

Illustration shows Hydrozone XD™ 1.5m swim spa model

| | | Hydrozone™ | Hydrozone XD™ |
|------------------|--|-------------------|--------------------|
| Model dimensions | | 5.89(L) x 2.30(W) | 5.89(L) x 2.30(W)m |
| A | Total height +/-20mm | 1.28m | 1.49m |
| B | Product height under lip +/-20mm | 1,180mm | 1,400mm |
| C | Height to bottom of health light +/-25mm | 991mm | 1,195mm |
| D | Water depth from floor to recommended fill level | 1,070/665mm | 1,290/665mm |

Hydrozone™

Jet Specifications

Dimensions: 5.89 x 2.30 x 1.28/1.49m

The spa jet configuration is the same on all Hydrozone™ and Hydrozone XD™ swim spa models.

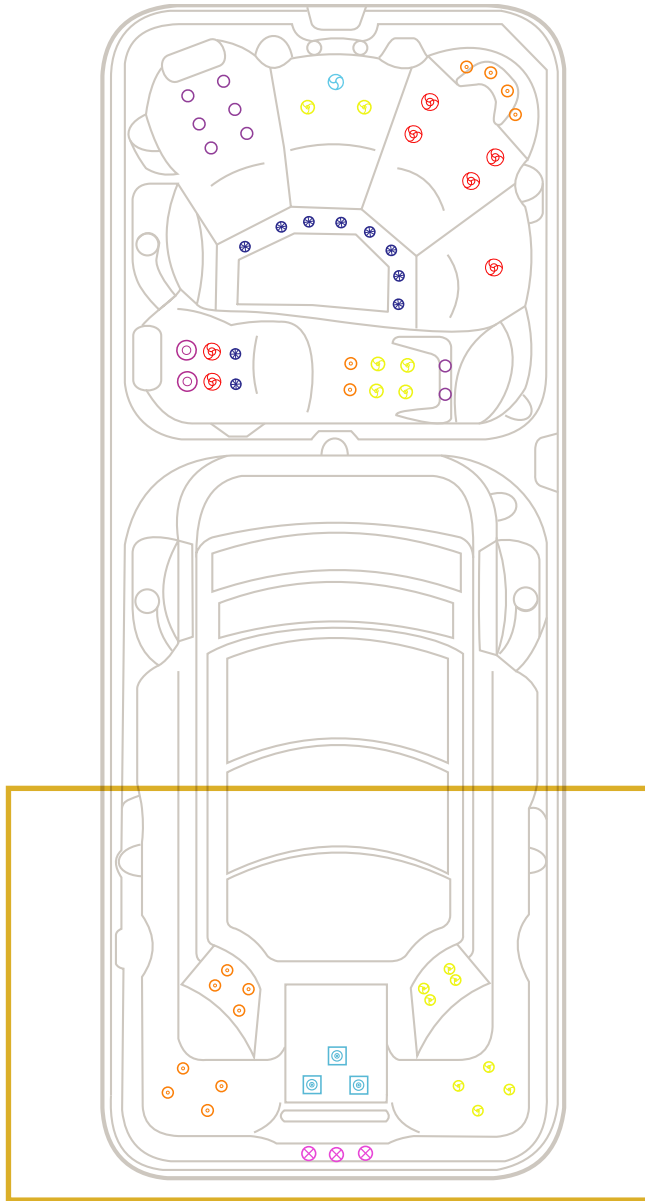

Illustration shows our most popular swim spa Hydrozone Pro+™ model.

 140mm Single Roto Jets

 140mm Directional Jets

 100mm Directional Jets

 50mm Air Jets

 63mm Directional Jets

 63mm Roto Jets

 100mm Single Roto Jets

 Laminar Jets

Hydrozone Plunge™

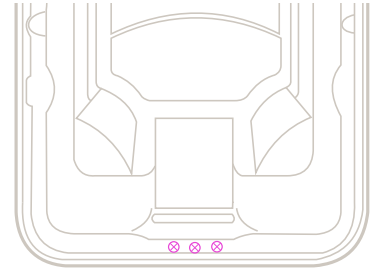

Hydrozone Pro™

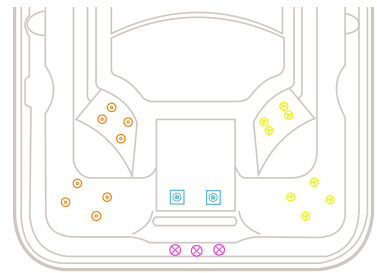

Hydrozone Pro+™

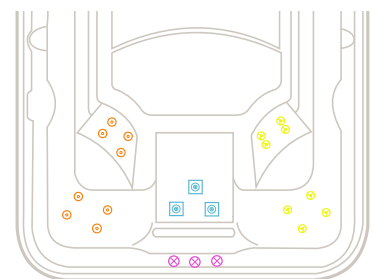

Hydrozone Extreme™

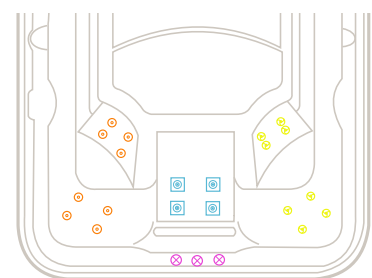

 127mm Square Swim Jets

* Conditions apply. Specifications may change without notice. Pictures may show options not available on all models.

Hydrozone™

Specifications Table (Non-ClearLift™ models)

| | | Plunge™ | Pro™ | Pro Plus™ | Extreme™ |
|--|-------|---|---|---|---|
| Water capacity | | | | | |
| Hydrozone™ | 1.3m | 7,045L | 7,045L | 7,045L | 7,045L |
| Hydrozone XD™ | 1.49m | 7,474L | 7,474L | 7,474L | 7,474L |
| Dry weight (Note: For ClearLift™ models see next page.) | | | | | |
| Hydrozone™ | 1.3m | 1,380kg | 1,431kg | 1,480kg | 1,530kg |
| Hydrozone XD™ | 1.49m | 1,450kg | 1,500kg | 1,531kg | 1,575kg |
| Filled weight (incl cover) (Note: For ClearLift™ models see next page.) | | | | | |
| Hydrozone™ | 1.3m | 8,122kg | 8,173kg | 8,222kg | 8,272kg |
| Hydrozone XD™ | 1.49m | 8,982kg | 9,032kg | 9,063kg | 9,107kg |
| Lift weight** (Note: For ClearLift™ models see next page.) | | | | | |
| Hydrozone™ | 1.3m | 1,758kg** | 1,819kg** | 1,878kg** | 1,938kg** |
| Hydrozone XD™ | 1.49m | 1,843kg** | 1,903kg** | 1,940kg** | 1,993kg** |
| Intuitive spa controller | | SV2 + SV3 | SV2 + SV3 | SV2 + SV3 | SV2 + SV4 |
| Power cable length*** | | SV2 - 5m cable SV3 - Hardwired by a licensed electrician | SV2 - 5m cable SV3 - Hardwired by a licensed electrician | SV2 - 5m cable SV3 - Hardwired by a licensed electrician | SV2 - 5m cable SV4 - Hardwired by a licensed electrician |
| Programmable circulation pump | | 2 | 2 | 2 | 2 |
| Jet pumps | | 1 + 1 | 2 + 1 | 3 + 1 | 4 + 1 |
| Variable speed air blower | | 1 | 1 | 1 | 1 |
| Variable output heater | | 3kW + 5.25kW | 3kW + 5.25kW | 3kW + 5.25kW | 3kW + 5.25kW |
| Recommended electrical supply | | 15 + 32 amps | 15 + 32 amps | 15 + 32 amps | 15 + 40 amps |

** The specified lift weights in the table above include the spa's dry weight, packaging, hard cover and water, but not the pallet weight. These are approximate weights and are intended as a guide only. All weights must be checked by the crane operator prior to the lift. (Cranes have the ability to check the weight)

*** The cable length is measured from the spa control box to the plug. For instance, if you prefer to exit the cable from the rear of a 2m spa (on the side opposite the control box), the length of the cable outside the spa will be only 3m (subtracting the 2m from the control box to the rear of the spa from the total cable length of 5m).

* Conditions apply. Specifications may change without notice. Pictures may show options not available on all models.

Hydrozone™

Specifications Table (ClearLift™ models)

| | | Plunge™ | Pro™ | Pro Plus™ | Extreme™ |
|--|------|---|---|---|---|
| Water capacity | | | | | |
| Hydrozone™ | 1.3m | 7,045L | 7,045L | 7,045L | 7,045L |
| Hydrozone XD™ | 1.5m | 7,474L | 7,474L | 7,474L | 7,474L |
| Dry weight (Note: For Non-ClearLift™ models see previous page.) | | | | | |
| Hydrozone™ | 1.3m | 1,536kg | 1,587kg | 1,636kg | 1,686kg |
| Hydrozone XD™ | 1.5m | 1,606kg | 1,656kg | 1,687kg | 1,731kg |
| Filled weight (incl cover) (Note: For Non-ClearLift™ models see previous page.) | | | | | |
| Hydrozone™ | 1.3m | 8,258kg | 8,309kg | 8,358kg | 8,408kg |
| Hydrozone XD™ | 1.5m | 9,118kg | 9,168kg | 9,199kg | 9,243kg |
| Lift weight** (Note: For Non-ClearLift™ models see previous page.) | | | | | |
| Hydrozone™ | 1.3m | 1,894kg** | 1,955kg** | 2,014kg** | 2,074kg** |
| Hydrozone XD™ | 1.5m | 1,979kg** | 2,039kg** | 2,076kg** | 2,129kg** |
| Intuitive spa controller | | SV2 + SV3 | SV2 + SV3 | SV2 + SV3 | SV2 + SV4 |
| Power cable length*** | | SV2 - 5m cable SV3 - Hardwired by a licensed electrician | SV2 - 5m cable SV3 - Hardwired by a licensed electrician | SV2 - 5m cable SV3 - Hardwired by a licensed electrician | SV2 - 5m cable SV4 - Hardwired by a licensed electrician |
| Programmable circulation pump | | 2 | 2 | 2 | 2 |
| Jet pumps | | 1 + 1 | 2 + 1 | 3 + 1 | 4 + 1 |
| Variable speed air blower | | 1 | 1 | 1 | 1 |
| Variable output heater | | 3kW + 5.25kW | 3kW + 5.25kW | 3kW + 5.25kW | 3kW + 5.25kW |
| Recommended electrical supply | | 15 + 32 amps | 15 + 32 amps | 15 + 32 amps | 15 + 40 amps |

** The specified lift weights in the table above include the spa's dry weight, packaging, hard cover and water, but not the pallet weight. These are approximate weights and are intended as a guide only. All weights must be checked by the crane operator prior to the lift. (Cranes have the ability to check the weight)

*** The cable length is measured from the spa control box to the plug. For instance, if you prefer to exit the cable from the rear of a 2m spa (on the side opposite the control box), the length of the cable outside the spa will be only 3m (subtracting the 2m from the control box to the rear of the spa from the total cable length of 5m).

* Conditions apply. Specifications may change without notice. Pictures may show options not available on all models.

Hydrozone Plunge™

Equipment Location

| | |
|---|---------------------------|
|  | Equipment Bay |
|  | Keypad |
|  | Keypad Swim end |
|  | Conduit Access* |
|  | Drain Valve Swim end |
|  | Drain Valve Spa end |
|  | Circulation Pump Swim end |
|  | Circulation Pump Spa end |
|  | Jet Pump Spa end |
|  | Speaker holders |
|  | Swimming Pole Socket |

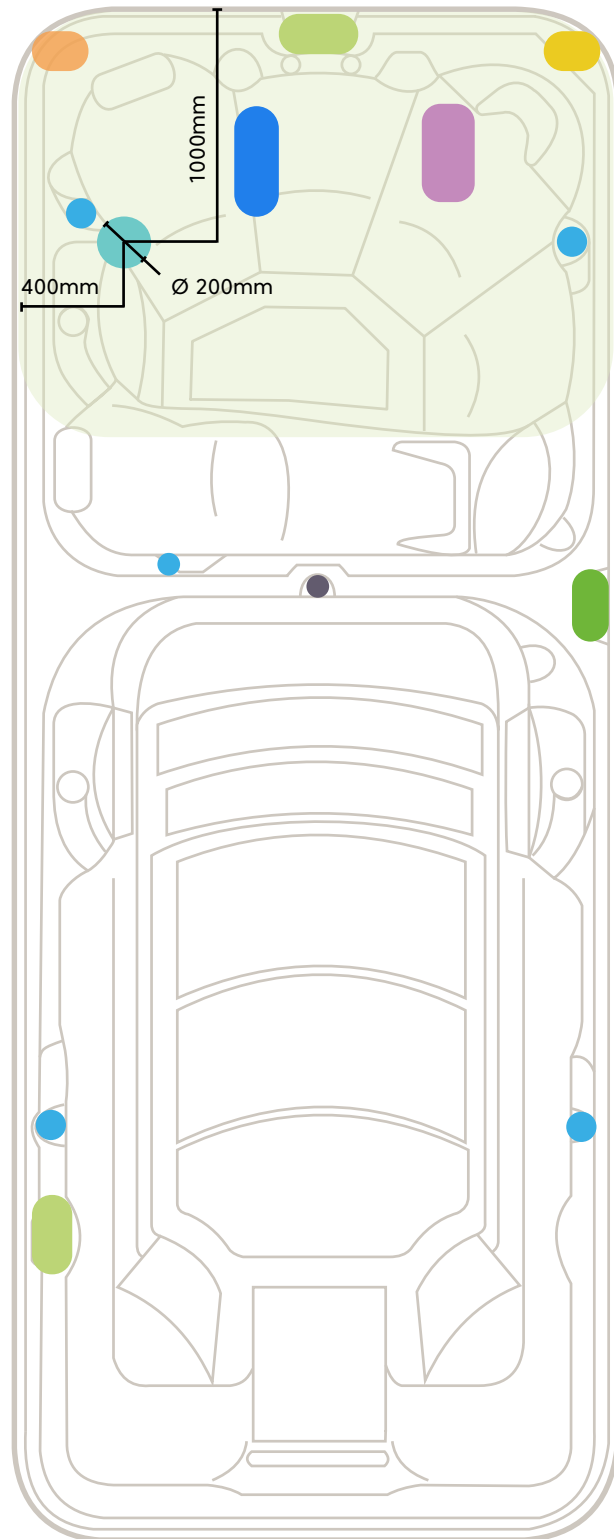













* Conduit should not stick above the concrete slab more than 100mm.

Note: This model has a rigid base, and if you choose to bring the piping conduit in from the bottom through the base, you will need to cut a hole into the base on-site before installation. The factory does not provide this hole. Please see the diagram above to find the location where you can drill the hole.

Hydrozone Pro™

Equipment Location

| | |
|---|------------------------------|
|  | Equipment Bay |
|  | Keypad |
|  | Keypad Swim end |
|  | Conduit Access* |
|  | Drain Valve Swim end |
|  | Drain Valve Spa end |
|  | Circulation Pump Swim end |
|  | Jet Pump Swim end |
|  | Circulation Pump Spa end |
|  | Jet Pump Spa end |
|  | Speaker holders |
|  | Swimming Pole Socket |

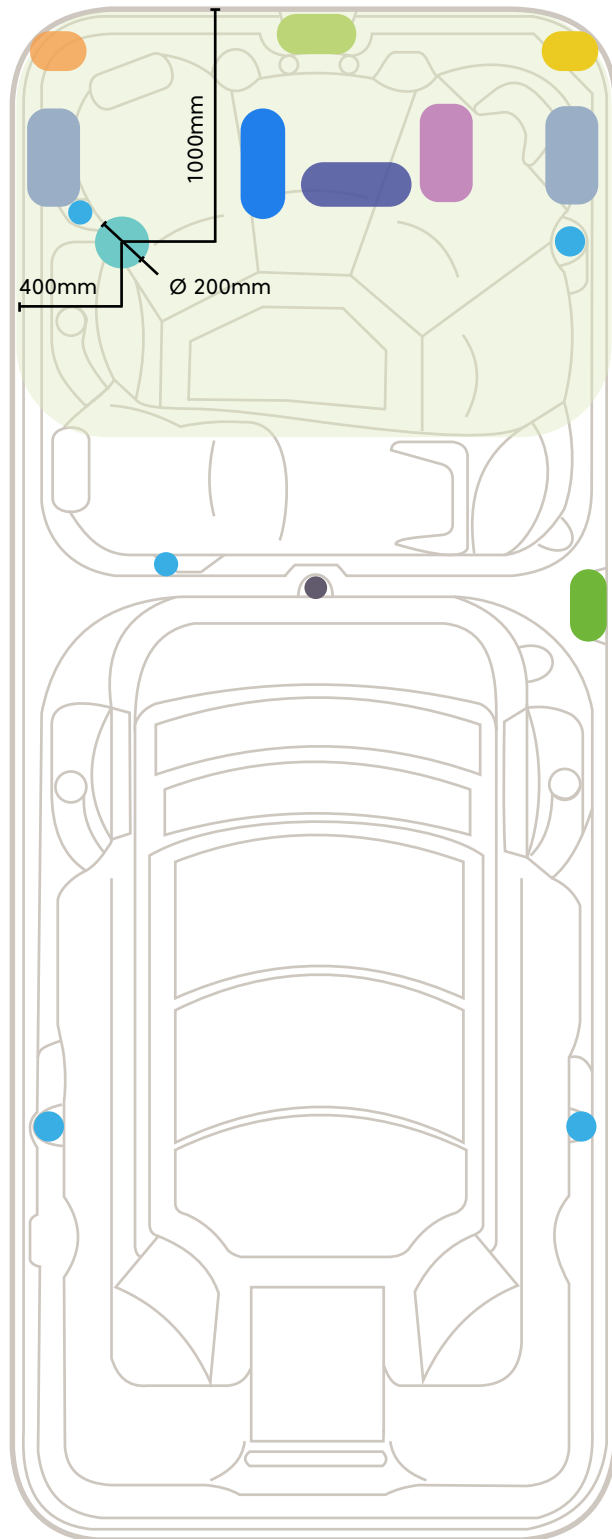













* Conduit should not stick above the concrete slab more than 100mm.

Note: This model has a rigid base, and if you choose to bring the piping conduit in from the bottom through the base, you will need to cut a hole into the base on-site before installation. The factory does not provide this hole. Please see the diagram above to find the location where you can drill the hole.

Hydrozone Pro+™

Equipment Location

| | |
|---|---------------------------|
|  | Equipment Bay |
|  | Keypad |
|  | Keypad Swim end |
|  | Conduit Access* |
|  | Drain Valve Swim end |
|  | Drain Valve Spa end |
|  | Circulation Pump Swim end |
|  | Jet Pump Swim end |
|  | Circulation Pump Spa end |
|  | Jet Pump Spa end |
|  | Speaker holders |
|  | Swimming Pole Socket |

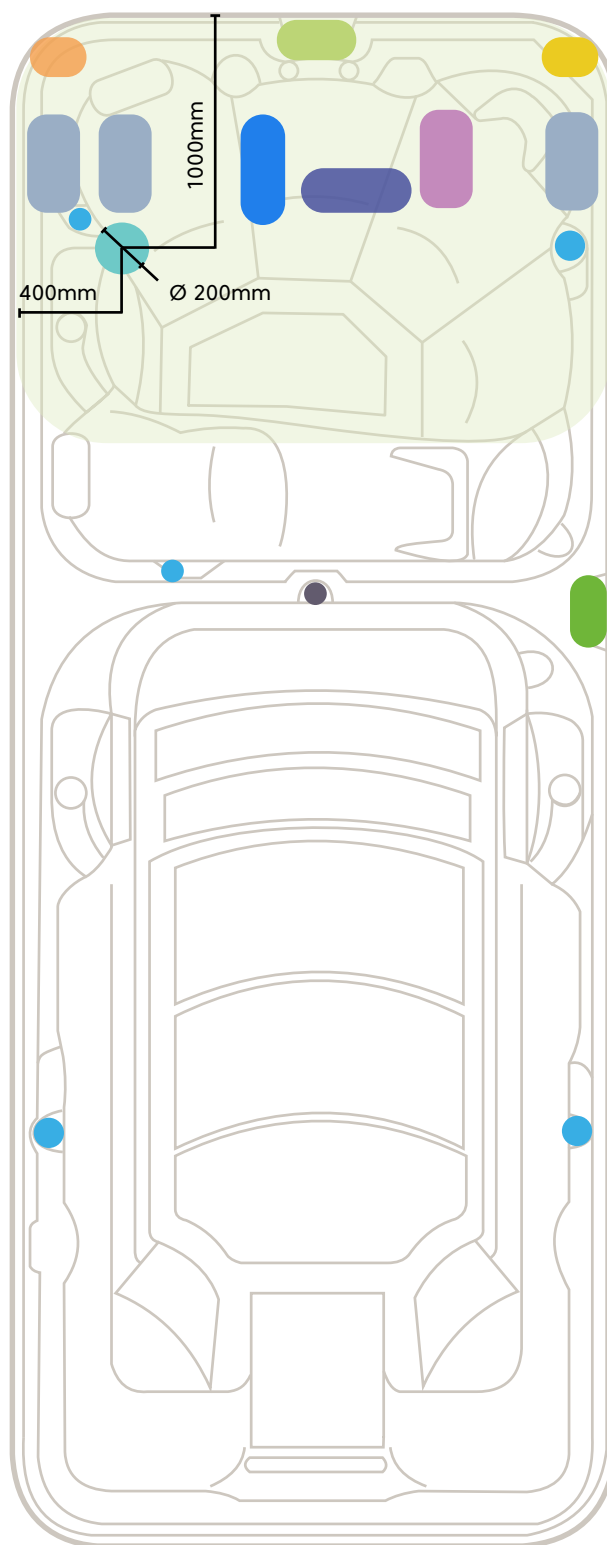













* Conduit should not stick above the concrete slab more than 100mm.

Note: This model has a rigid base, and if you choose to bring the piping conduit in from the bottom through the base, you will need to cut a hole into the base on-site before installation. The factory does not provide this hole. Please see the diagram above to find the location where you can drill the hole.

Hydrozone Extreme™

Equipment Location

| | |
|---|---------------------------|
|  | Equipment Bay |
|  | Keypad |
|  | Keypad Swim end |
|  | Conduit Access* |
|  | Drain Valve Swim end |
|  | Drain Valve Spa end |
|  | Circulation Pump Swim end |
|  | Jet Pump Swim end |
|  | Circulation Pump Spa end |
|  | Jet Pump Spa end |
|  | Speaker holders |
|  | Swimming Pole Socket |

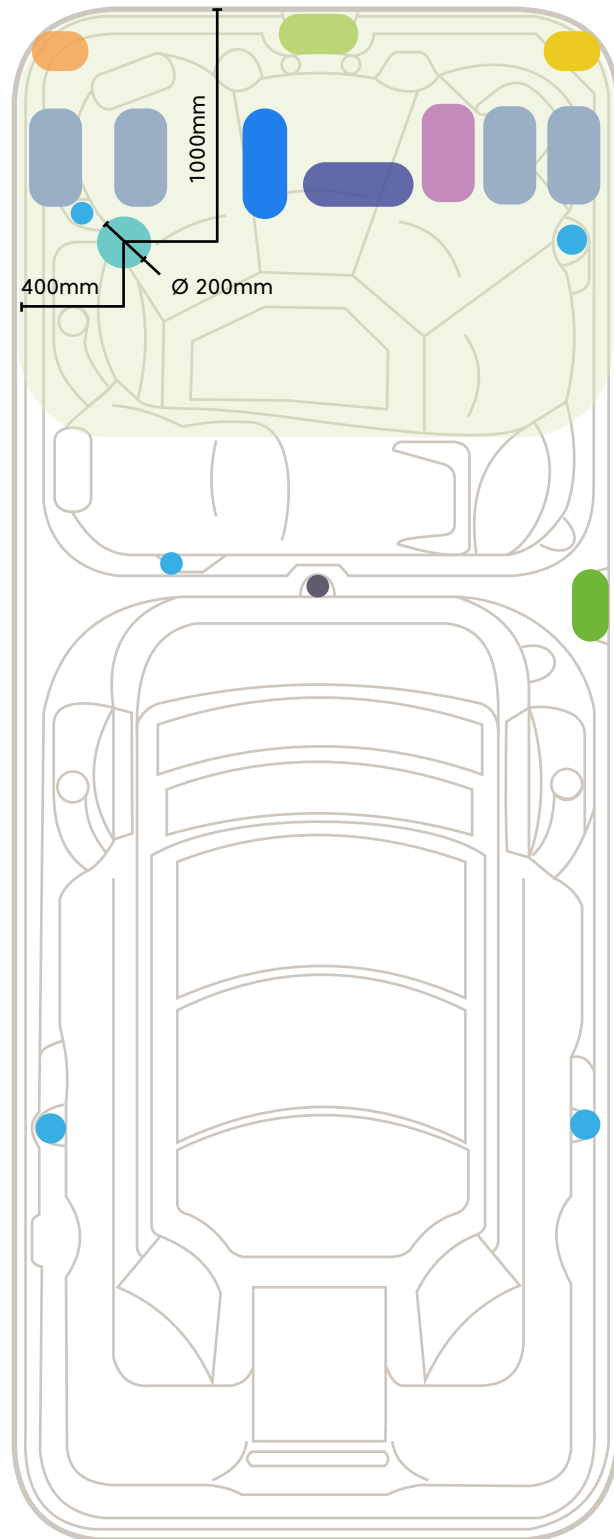

* Conduit should not stick above the concrete slab more than 100mm.

Note: This model has a rigid base, and if you choose to bring the piping conduit in from the bottom through the base, you will need to cut a hole into the base on-site before installation. The factory does not provide this hole. Please see the diagram above to find the location where you can drill the hole.

Hydrozone™

Deck/Pit Installation

Follow this step-by-step guide to ensure your spa remains fully accessible for servicing and upgrades, without compromising your deck/pit design.

1. Leave space between the decking and the lip of the spa.

- Do not run deck boards flush with the underside of the spa shell. This setup is unsafe and not recommended.
- **Set the spa at least 400mm above deck height (to the top of the spa):** Ensures safe and easy entry/exit. Allows cover safety clips to attach securely to the spa cabinet.
- Avoid finishing the spa lip level with the deck: Spa shells are hand-trimmed, so an exact level finish is unreliable. Misalignment is likely, especially over time.
- Risk of structural damage: If foundations settle and the spa shell rests on the deck, it can cause cracking or damage. **This type of damage is not covered by warranty.**

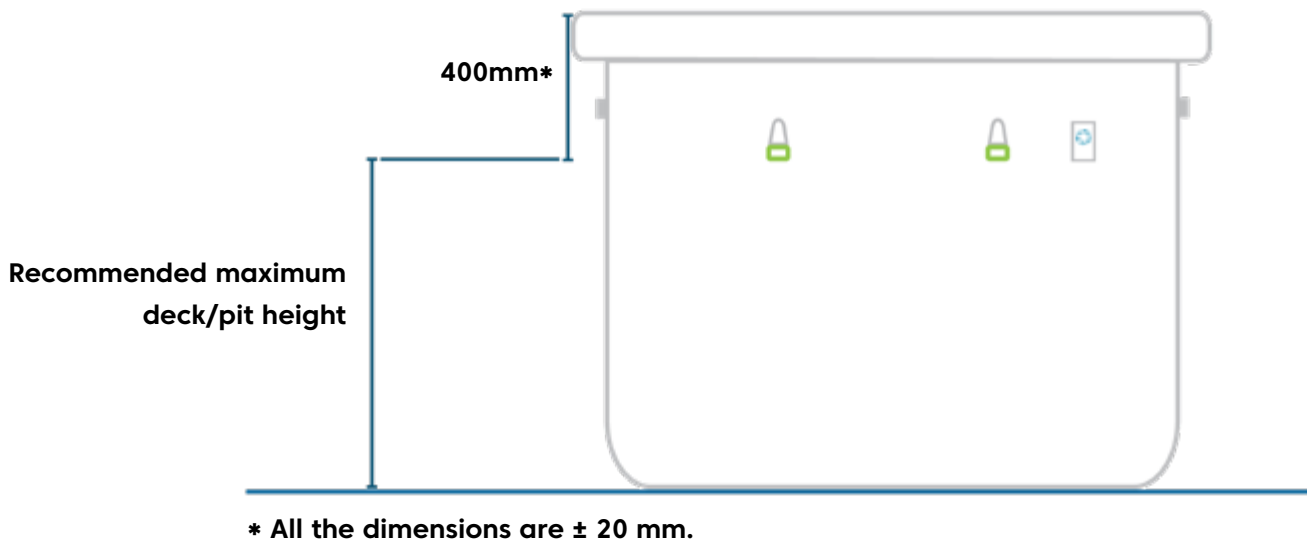

** The deck/pit installation instructions do not apply to Swim Spas with ClearLift™ cover. For more information about the ClearLift™ opening allowance, please refer to the ClearLift™ section on this tech pack.

* Conditions apply. Specifications may change without notice. Pictures may show options not available on all models.

Hydrozone™

Deck/Pit Installation

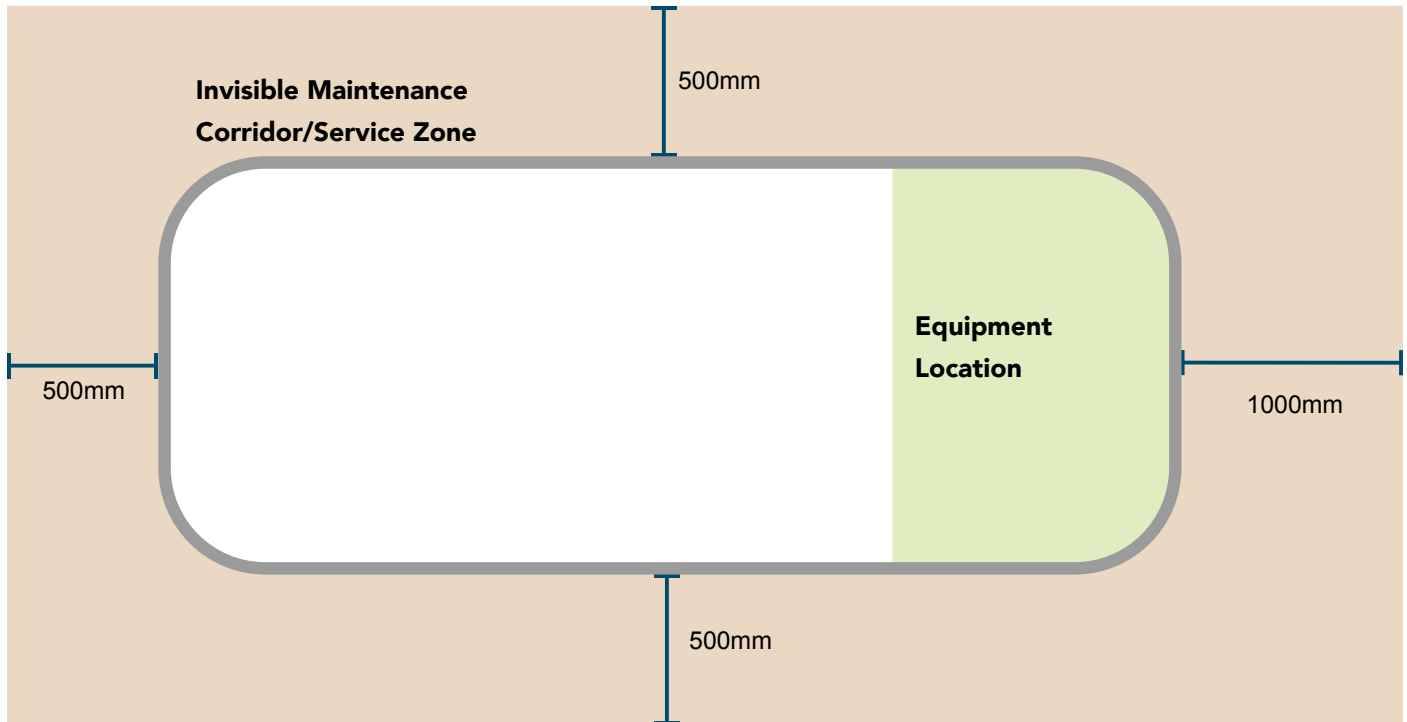

2. Visualise the Invisible Maintenance Corridor

Think of your spa as sitting inside an invisible service zone that technicians need to work freely.

- Leave 1000 mm (1 metre) clearance on the Equipment bay side.
- Leave 500 mm clearance on all other sides, measured from the spa cabinet—not the water edge or frame.

Tip: The invisible maintenance corridor zone must remain free of posts, joists, steps, balustrades, fencing or other obstructions.

* The deck/pit installation instructions does not apply to Swim Spas with ClearLift™ cover. For more information about ClearLift™ opening allowance check the ClearLift™ section on this tech pack.

* Conditions apply. Specifications may change without notice. Pictures may show options not available on all models.

Hydrozone™

Deck/Pit Installation

3. Design Around the Swim Spa – Not Over It

Set back deck framing: Position beams outside the service corridor.

- Cantilever your joists to bridge the 500 mm or 1000 mm gap.
- Frame removable hatch panels into the decking that sits over the service zones. These hatches allow future access to pumps, plumbing, and equipment without pulling up your deck or dismantling timber.

Side Angle View Deck Cut-Out Service Corridor and Crawl Space Access

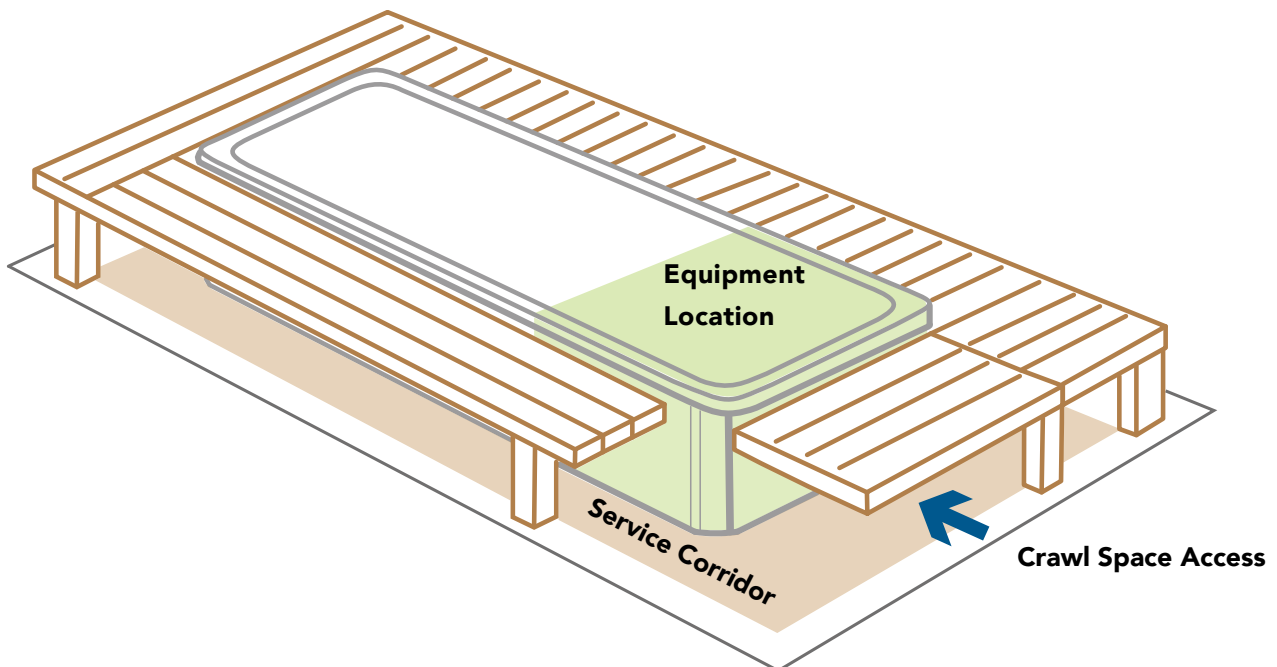

4. Add Drop-in Lids or Crawl Space Access

Underneath any decking above a service zone:

- Provide drop-in lids or crawl space access. This lets technicians get to every panel on every side of the spa, even those not facing outward.

Long-term servicing, warranty work, and equipment upgrades all depend on this kind of access!

* The deck/pit installation instructions does not apply to Swim Spas with ClearLift™ cover. For more information about ClearLift™ opening allowance check the ClearLift™ section on this tech pack.

* Conditions apply. Specifications may change without notice. Pictures may show options not available on all models.

Hydrozone™

Deck/Pit Installation

Front View Deck Cut-out Service Corridor



Side View Deck Cut-out Crawl Space Access

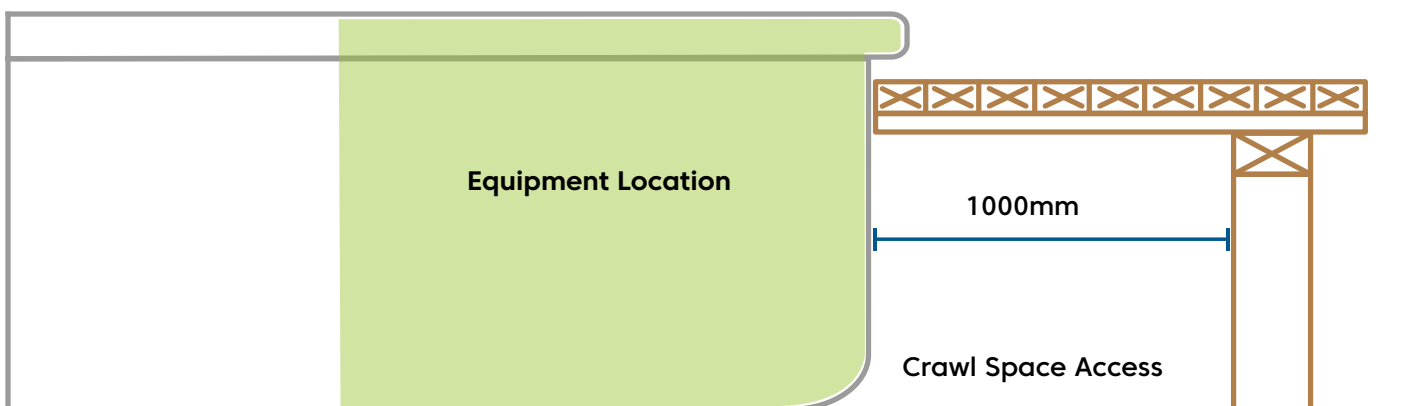

* The deck/pit installation instructions does not apply to Swim Spas with ClearLift™ cover. For more information about ClearLift™ opening allowance check the ClearLift™ section on this tech pack.

* Conditions apply. Specifications may change without notice. Pictures may show options not available on all models.

Hydrozone™

Deck/Pit Installation

5. Prepare Swim Spa Cabinet Panels Before Decking/Pit (optional)

Before any boards go down:

- Mark a horizontal line just below your planned future deck height on each spa cabinet panel.
- Unscrew and remove the entire panel.
- Cut it in two parts:
 - The upper section will lift out from above the deck.
 - The lower section will slide out through the gap beneath.

Pre-cutting ensures panels can be removed without cutting into the spa's frame, insulation, wiring or plumbing.

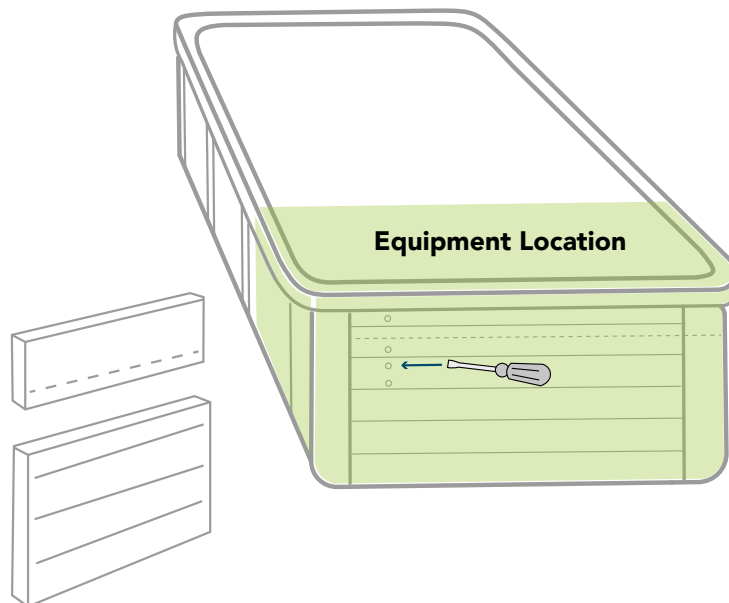

6. Reinstall the Cabinet Panels – Now Split for Access

- Once cut: Reinstall the lower section below deck height.
- Store or safely keep the upper section to reattach once the deck is in place.

This prep means panels can be accessed from above or below the deck—without compromising spa structure or warranty.

* The deck/pit installation instructions does not apply to Swim Spas with ClearLift™ cover. For more information about ClearLift™ opening allowance check the ClearLift™ section on this tech pack.

* Conditions apply. Specifications may change without notice. Pictures may show options not available on all models.

Hydrozone™

Deck/Pit Installation

7. Double-Check Before Final Decking

Before securing your final boards confirm all clearances:

- 1000 mm on the equipment side
- 500 mm on all other sides
- Confirm hatch panels and access points align with service zones.
- Confirm cabinet panels are divided and re-installable.

You're Set Up for Success

By following this method, you'll:

- Protect your spa's warranty
- Avoid costly rework later
- Make future servicing simple
- Keep your decking clean and elegant with hidden hatches and clever framing.

* The deck/pit installation instructions does not apply to Swim Spas with ClearLift™ cover. For more information about ClearLift™ opening allowance check the ClearLift™ section on this tech pack.

* Conditions apply. Specifications may change without notice. Pictures may show options not available on all models.

Hydrozone™

Standard Spa Cover

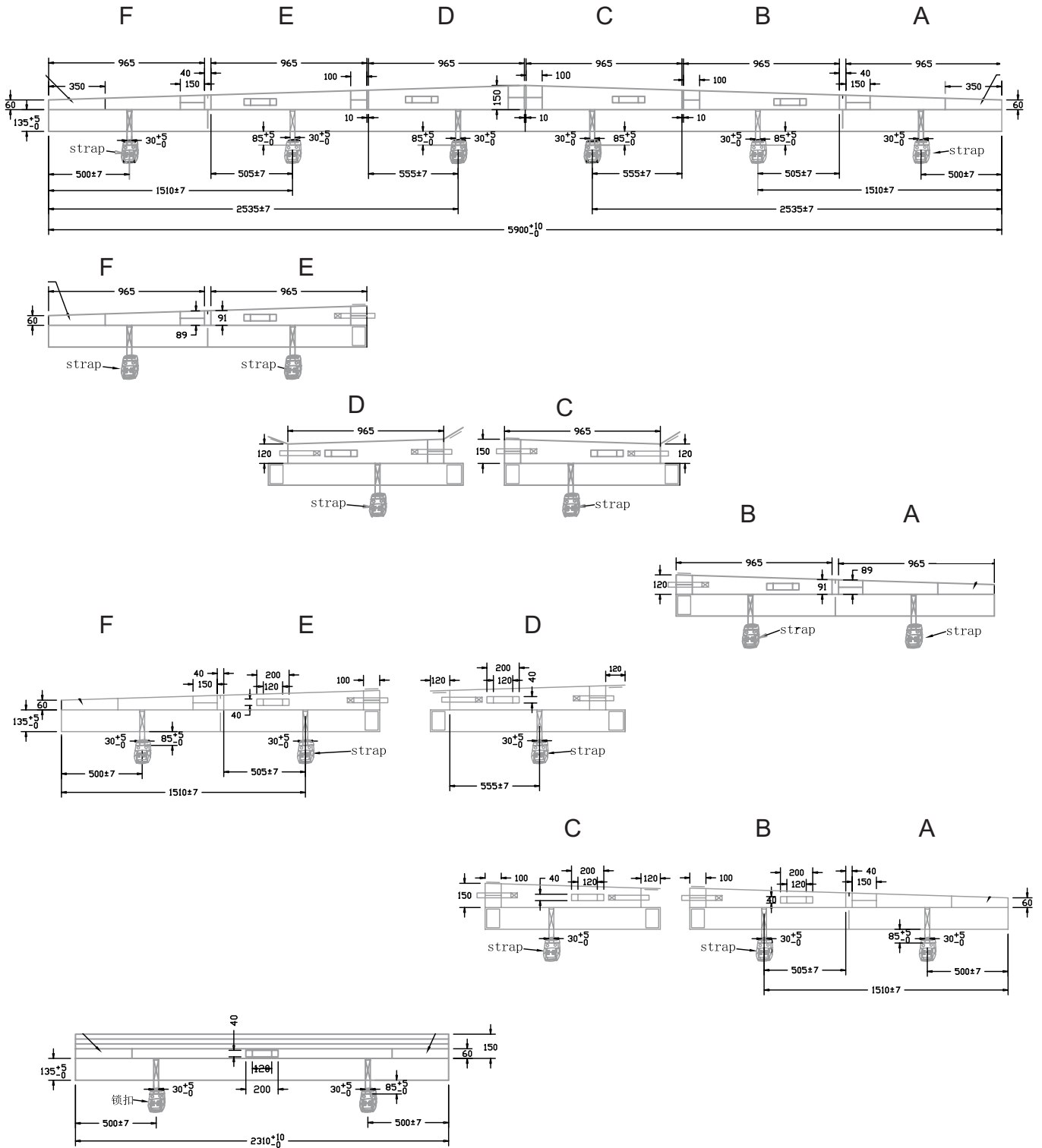

Hydrozone™

Optional ClearLift™ Cover

Left-mounted opening

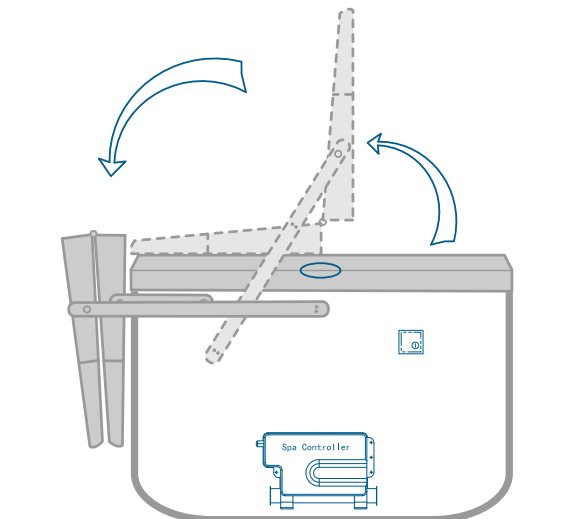

Right-mounted opening

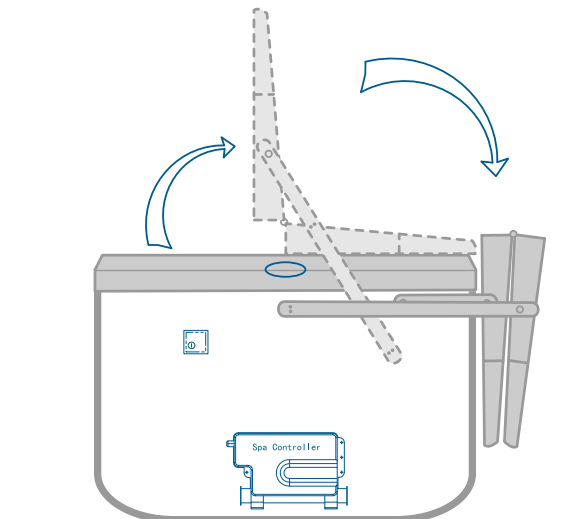

If the ClearLift™ control panel is positioned on the right side of the swim spa, and the ClearLift™ cover folds to the left, it is considered a **Left-Mounted ClearLift™**.

Conversely, if the ClearLift™ control panel is located on the left side of the swim spa, and the ClearLift™ cover folds to the right, it is referred to as a **Right-Mounted ClearLift™**.

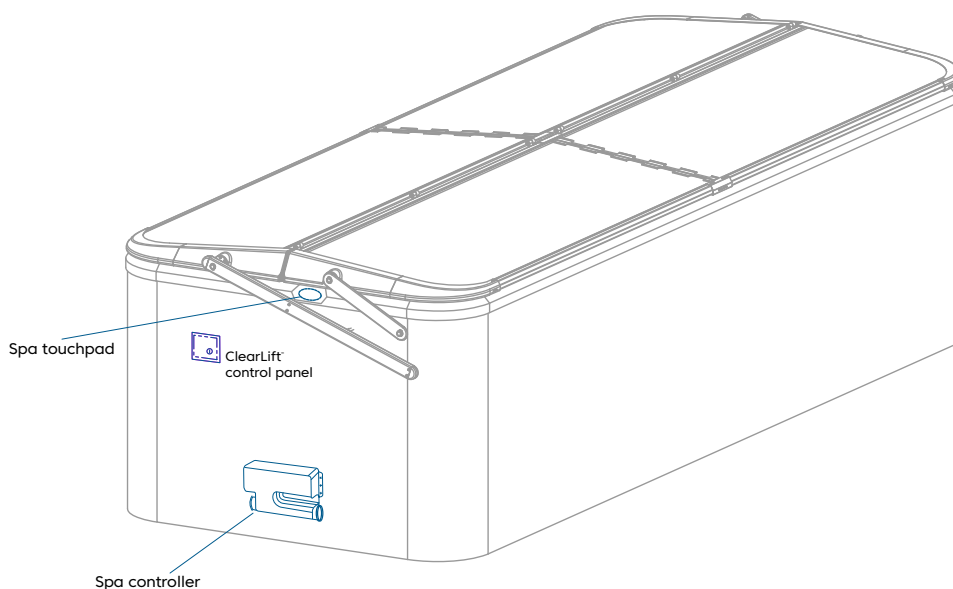

*The illustration shows Right-mounted opening, side angle view.

Note: The ClearLift™ control panel is installed at the same end as the swim spa controller keypad.

Hydrozone™

Optional ClearLift™ Cover opening allowance

Left mount, side view shown in Vortex™ swim spas 1,300mm height.

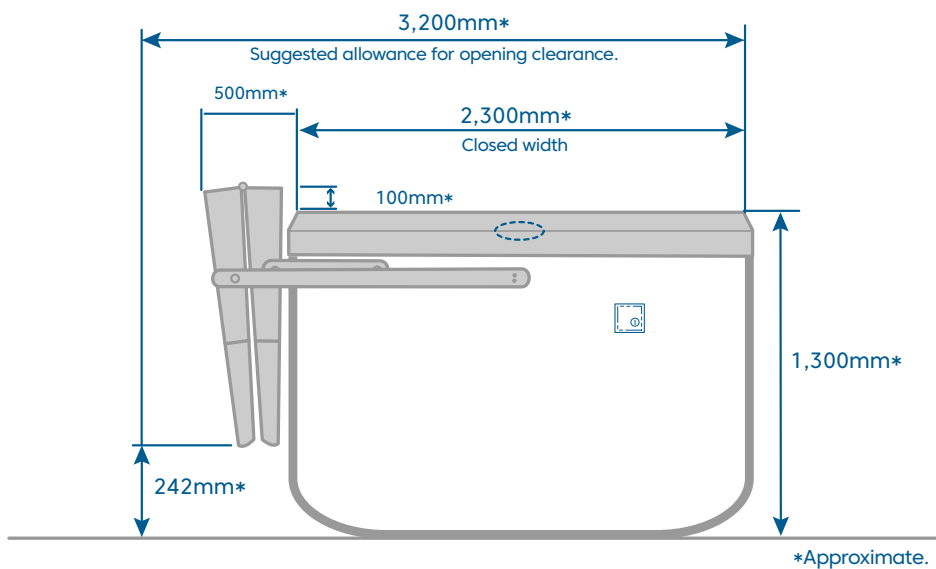
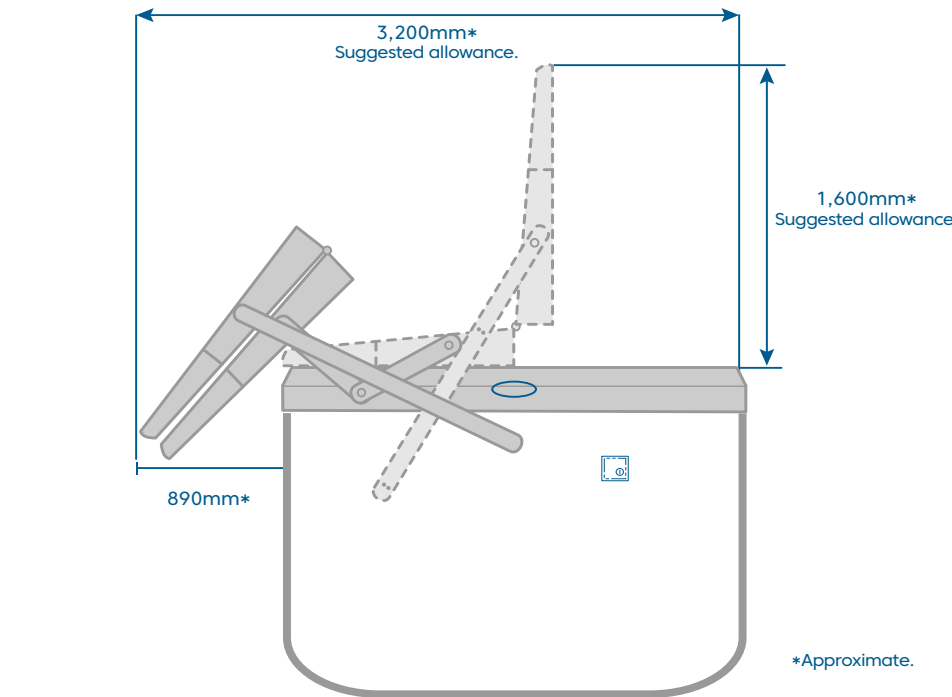

Hydrozone XD™

Optional ClearLift™ Cover opening allowance

Left mount, side view shown in Vortex™ swim spas 1,500mm height.

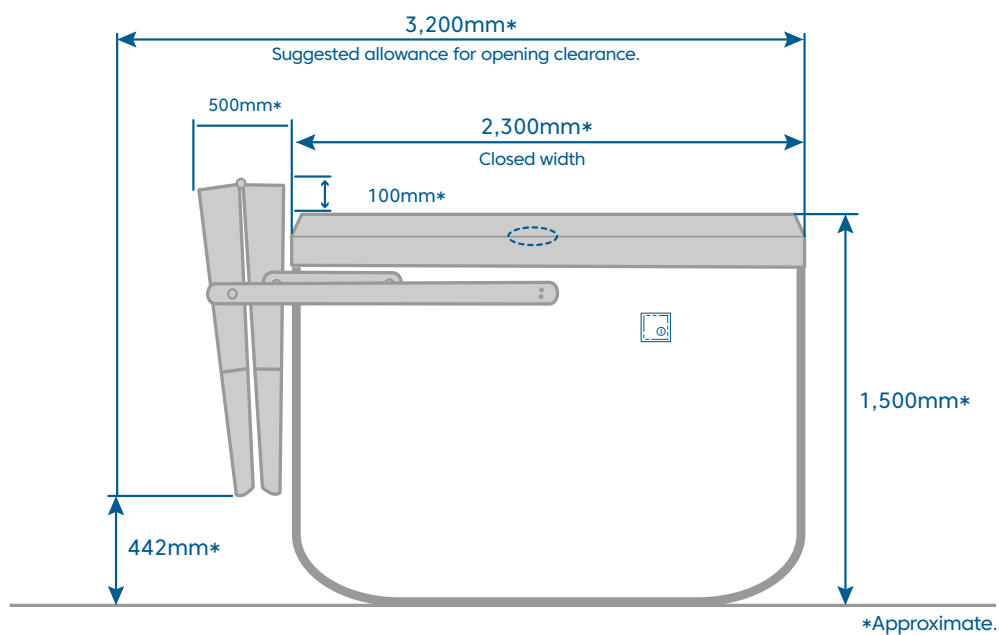
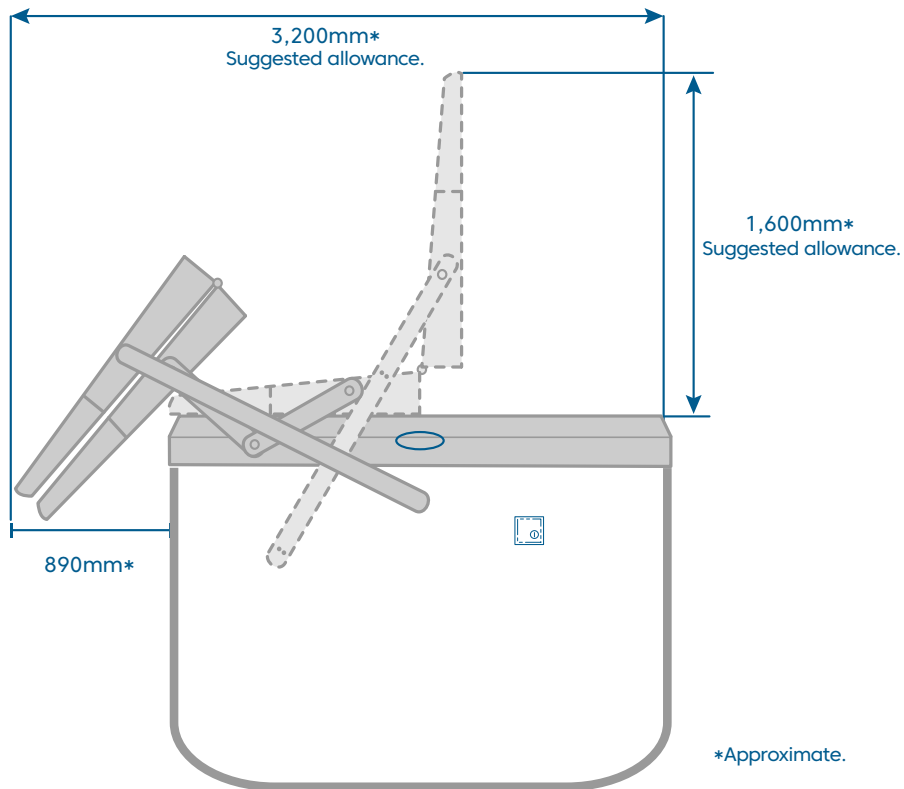

Hydrozone™

Vortex Spas™ Plumbing Certificates

To access each of the Vortex Hydrozone models' Plumbing Certificates, please click or scan the QR code associated with each model.

Click on QR code



Scan QR code



**Vortex Hydrozone™ Plunge
Plumbing Certificate**

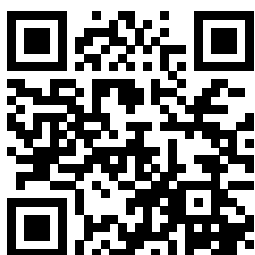

**Vortex Hydrozone™ Extreme
Plumbing Certificate**



**Vortex Hydrozone™ Pro
Plumbing Certificate**

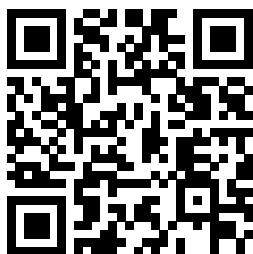

**Vortex Hydrozone™ Pro+
Plumbing Certificate**



Hydrozone™

Vortex Spas™ Certificates

To access the Vortex Hydrozone™ Generic Concrete Slab/ Structural Certificates, please click or scan the QR code associated with each model.

Click on QR code



**Vortex™ Swim Spas
Generic Concrete Slab
Certificate**

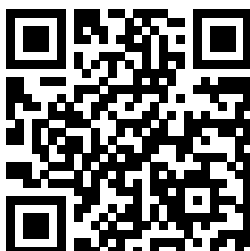

Scan QR code



**Vortex Hydrozone™
Structural Certificate**



**Vortex Hydrozone XD™
Structural Certificate**

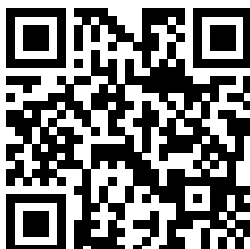

Vortex Spas™ Limited Warranty

To access the Vortex Spas™ Limited Warranty:

Click on QR code



Scan QR code



**Vortex Spas™ 2024
Limited Warranty**



**Vortex Spas™ Pre-2024
Limited Warranty**

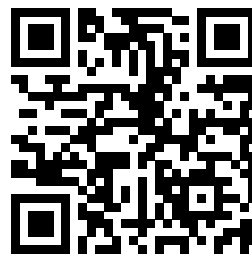

Vortex Spas™ Owner's Manuals

To access more information about Vortex™ Spa:

Click on QR code



Vortex Spas™
Owner's Manual

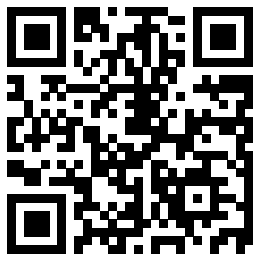

Scan QR code



Vortex Spas™
Audio WiFi Manual

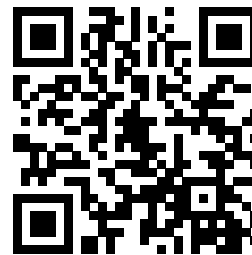

ClearLift™ Cover
Manual

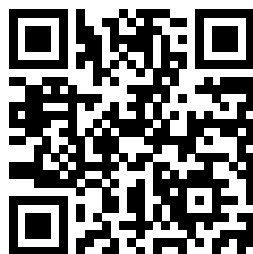



VortexTM
Spas